

COPPER PRESS FIT FITTINGS

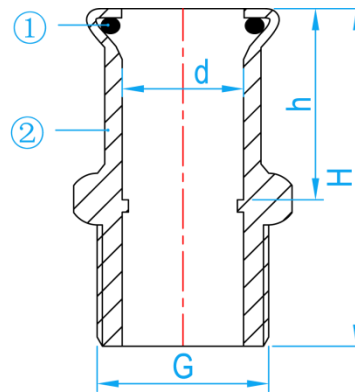

COMPLY WITH BSEN1254-2:1998

[MI] ADAPTOR



CROSS SECTIONAL VIEW

DIMENSIONS

SKU	SIZE (mm)	d (mm)	h (mm)	H (mm)	G (mm)	WEIGHT (Kg)	PCS/CTN
PFNMIA015	15	15	20	43.5	1/2"	0.053	300
PFNMIA020	22	22	21	46	3/4"	0.066	200
PFNMIA025	28	28	23	50	1"	0.104	132
PFNMIA035	35	35	26	56	1 1/4"	0.165	60
PFNMIA042	42	42	30	61	1 1/2"	0.212	48
PFNMIA050	54	54	35	71	2"	0.372	30
PFNMIA065	67	67	50	85	2 1/2"	0.638	24
PFNMIA080	76	76	55	95	3"	0.990	18