

COPPER PRESS FIT FITTINGS (M PROFILE)

COMPLY WITH BSEN1254-2: 1998

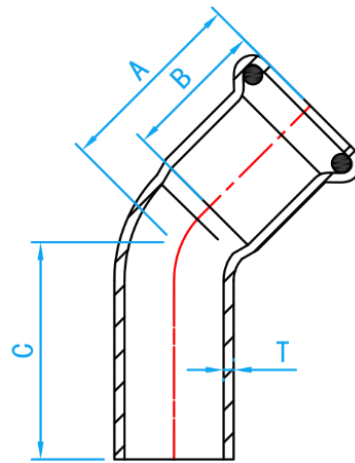

45° ELBOW MXF



CROSS SECTIONAL VIEW

DIMENSIONS

SKU	SIZE (mm)	A (mm)	B (mm)	C [mm]	T (mm)	WEIGHT (Kg)	PCS/CTN
PFNE45015MF	15	27.5	20	34.0	1.5	0.038	360
PFNE45020MF	22	32.0	21	42.0	1.5	0.066	120
PFNE45025MF	28	37.0	23	45.5	1.5	0.094	100
PFNE45035MF	35	43.5	26	58.0	1.5	0.148	48
PFNE45042MF	42	51.0	30	73.0	1.5	0.218	28
PFNE45050MF	54	62.0	35	85.0	1.5	0.331	16
PFNE45065MF	67	85.0	50	90.0	2.0	0.615	9
PFNE45080MF	76	91.0	50	97.0	2.0	0.888	6