

BRASS PRESS FIT Y STRAINER

COMPLY WITH BS EN 1092-2:1997

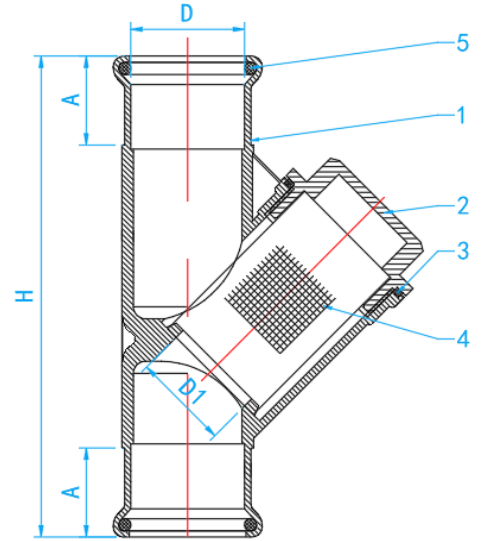

* Original Design By Norika®



CROSS SECTIONAL VIEW

STANDARD SPECIFICATIONS

Nominal Pressure	1.6Mpa
Working Medium	Water, Non Corrosive Liquid
Working Temperature	0°C<t≤100°C

STANDARD SCREENS

Size	Hole Dia (mm)	Mesh NO'S
DN015-065	3.0	22

COMPONENT PARTS

ITEM	PARTS	MATERIAL
1	Body	CW602N
2	Bonnet	CW602N
3	Valve Clack	PTFE
4	Filter	AISI304
5	O-ring	EPDM

DIMENSIONS

SKU	SIZE (inch)	D (mm)	D1 (mm)	A (mm)	H (mm)	WEIGHT (kg)	PACKAGE	
							PCS/BOX	PCS/CTN
YSCRPFN015	1/2"	15 ^{+0.2} / _{+0.3}	12	20	87	0.130	10	160
YSCRPFN020	3/4"	22 ^{+0.2} / _{+0.3}	19	21	101	0.230	10	100
YSCRPFN025	1"	28 ^{+0.2} / _{+0.3}	24	23	117	0.360	8	64
YSCRPFN035	1 1/4"	35 ^{+0.2} / _{+0.3}	28	26	117	0.425	6	48
YSCRPFN042	1 1/2"	42 ^{+0.2} / _{+0.3}	35	30	144	0.705	5	30
YSCRPFN050	2"	54 ^{+0.2} / _{+0.3}	45	36	174	1.133	4	16
YSCRPFN065	2 1/2"	67 ^{+0.2} / _{+0.3}	65.5	50	200	1.784	3	12