

HOT DIPPED GALVANIZED C CHANNEL BAR

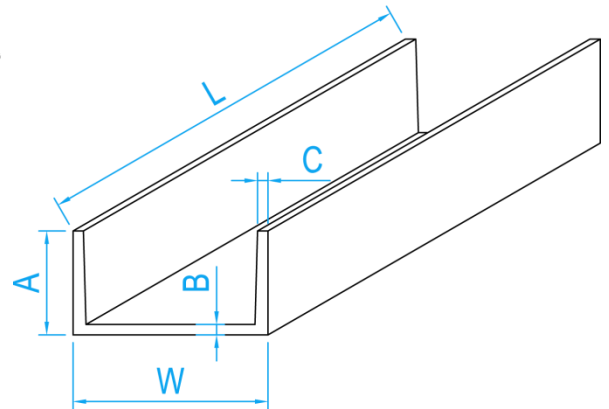
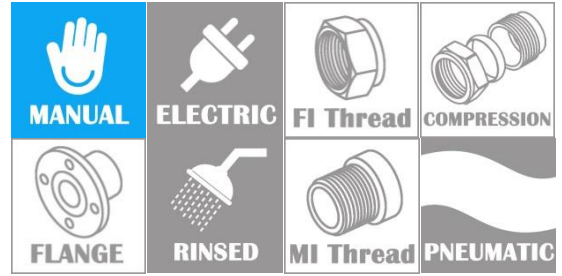

3-D VIEW

*Allowable thickness deviation +0.3mm or -0.5mm

DIMENSIONS

SKU	MATERIAL	L (mm)	W (mm)	A (mm)	B (mm)	C (mm)	WEIGHT (kg)
ACC02550	ALUMINIUM	6000	51.0	25.5	2.85	2.85	4.370
ACC04075	ALUMINIUM	6000	76.5	38.0	3.00	3.00	6.500
GICC05025	HOT DIPPED GALVANIZED	6000	50.0	34.0	3.20	3.80	20.000
GICC07540	HOT DIPPED GALVANIZED	6000	79.0	41.0	3.10	3.10	29.000
GICC10050	HOT DIPPED GALVANIZED	6000	100.0	46.0	3.00	4.00	39.000